

profilati profiles

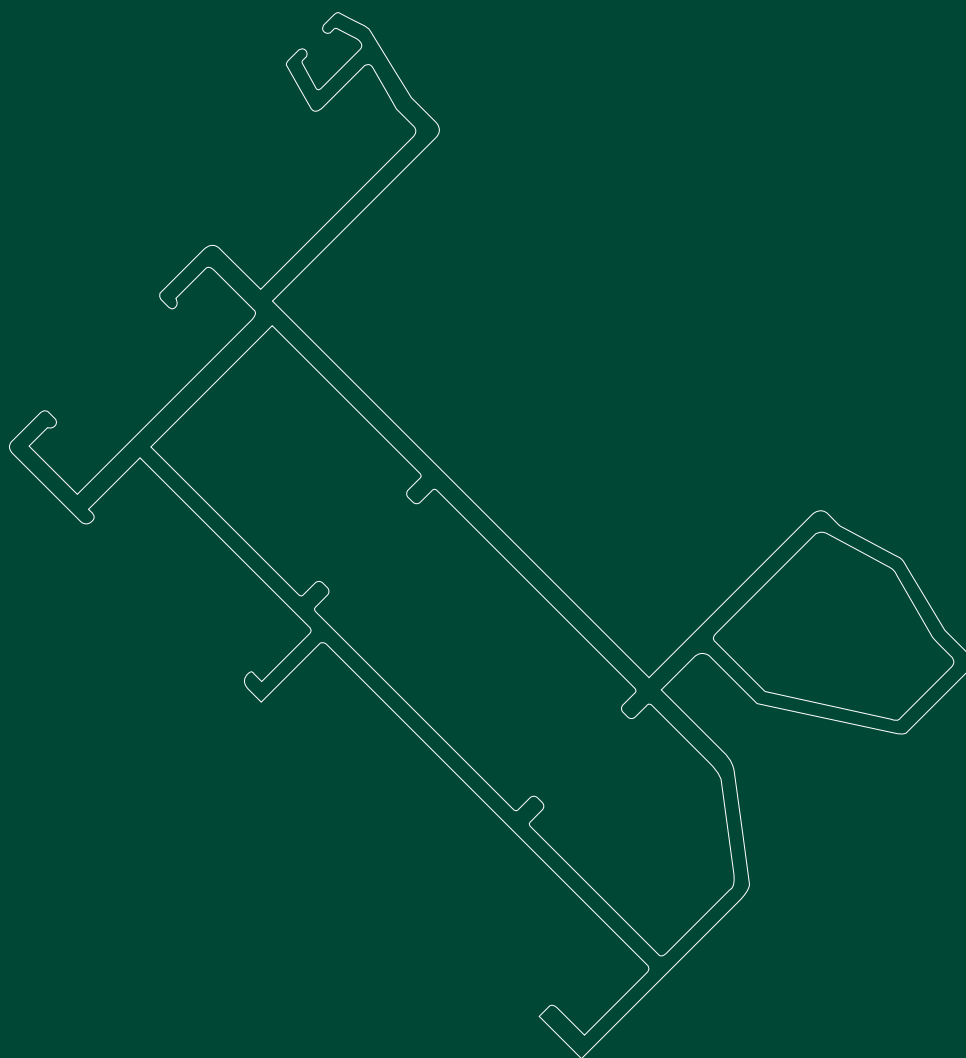

atlantis

serie wood slide
serie wood slide TT





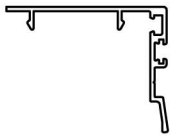
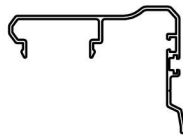

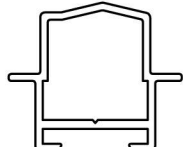
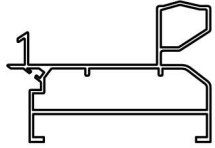
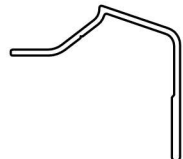
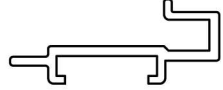

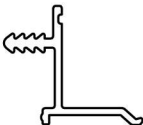
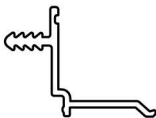
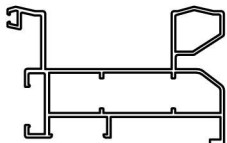
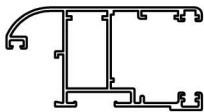
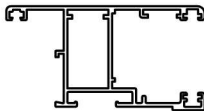
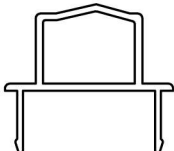
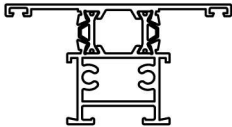

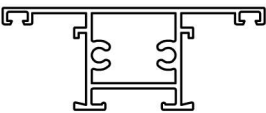
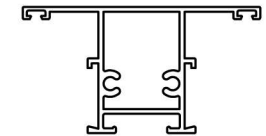
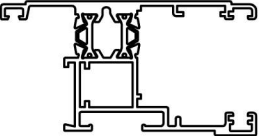
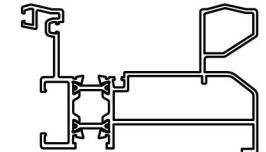
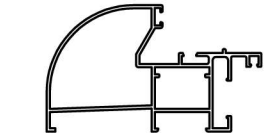
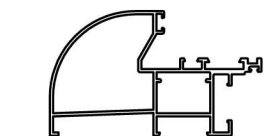

TO.MA. S.p.a.

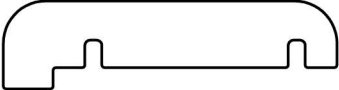
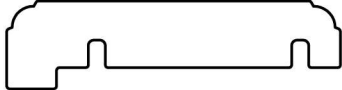
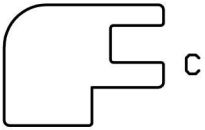
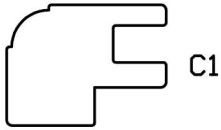

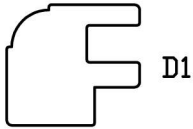
ESTRUSIONE ALLUMINIO

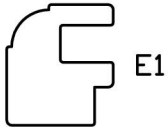
profili	sigla	peso gr/ml	utilizzazione
	AZ 3005	458	AGGANCIO CENTRALE INTERNO
	AZ 3006	680	AGGANCIO CENTRALE ESTERNO
	AZ 3007	230	FERMAVETRO - vuoto 25 mm -
	AZ 3008	481	RISCONTRO PER 4 ^a ANTA SISTEMA A TAGLIO TERMICO
	AZ 3009	1381	BINARIO MODULARE PER 3 ANTE
	AZ 3010	294	GOCCIOLATOIO
	AZ 3011	303	ASTINA DI CHIUSURA (solo per sistema freddo)

profili	sigla	peso gr/ml	utilizzazione
	AZ 3012	230	FERMAVETRO - vuoto 30 mm -
	AZ 3013	238	FERMAVETRO - vuoto 35 mm -
	AZ 3014	1650	BINARIO
	AZ 3015	1219	ANTA V.I.
	AZ 3016	1178	ANTA
	AZ 3017	421	RISCONTRO PER 4 ^a ANTA SISTEMA FREDDO
	AZ 3018	1250	TRAVERSO ANTA A TAGLIO TERMICO

profili	sigla	peso gr/ml	utilizzazione
	AZ 3019	920	TRAVERSO ANTA V.I.
	AZ 3020	1002	TRAVERSO ANTA
	AZ 3021	1473	ANTA A TAGLIO TERMICO
	AZ 3034	1872	BINARIO A TEGLIO TERMICO
	AZ 4909	1520	TELAIO PER ACCOPPIAMENTO CON ATLANTIS WOOD
	AZ 5018	1536	TELAIO PER ACCOPPIAMENTO CON ATLANTIS WOOD

linea arrotondata	linea scorniciata	accoppia con
<p>A</p> 	<p>A1</p> 	<p>AZ 3021 AZ 3016</p>
<p>B</p> 	<p>B1</p> 	<p>AZ 3005</p>
<p>C</p> 	<p>C1</p> 	<p>AZ 3007</p>
<p>D</p> 	<p>D1</p> 	<p>AZ 3012</p>
<p>E</p> 	<p>E1</p> 	<p>AZ 3013</p>
<p>F</p> 		<p>AZ 3034 AZ 3014</p>
<p>G</p> 	<p>G1</p> 	<p>AZ 3034 AZ 3014</p>

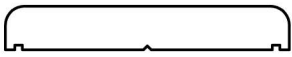
linea arrotondata	linea scornicialta	accoppia con
<p>H</p> 		<p>AZ 3015</p>
<p>I</p> 		<p>AZ 3020 AZ 3018</p>
<p>AL10</p> 		<p>AZ 5018 AZ 4909</p>
<p>L</p> 		<p>AZ 3019</p>

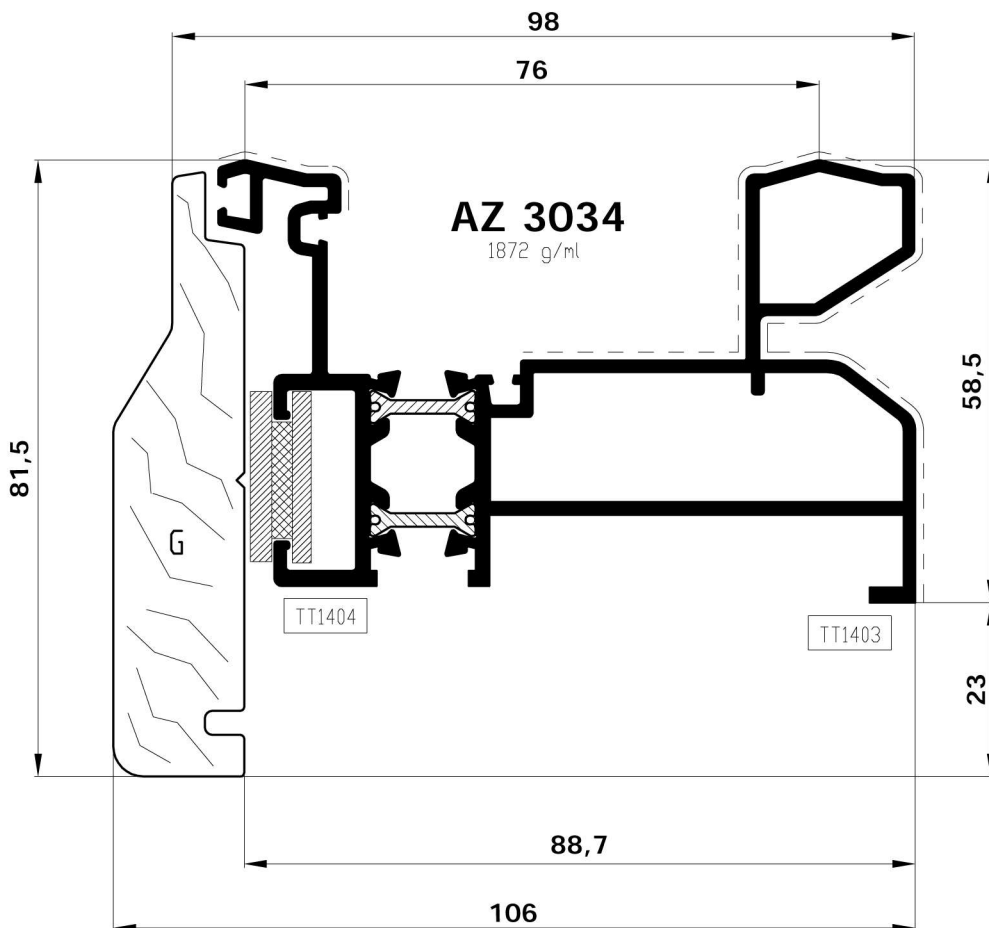
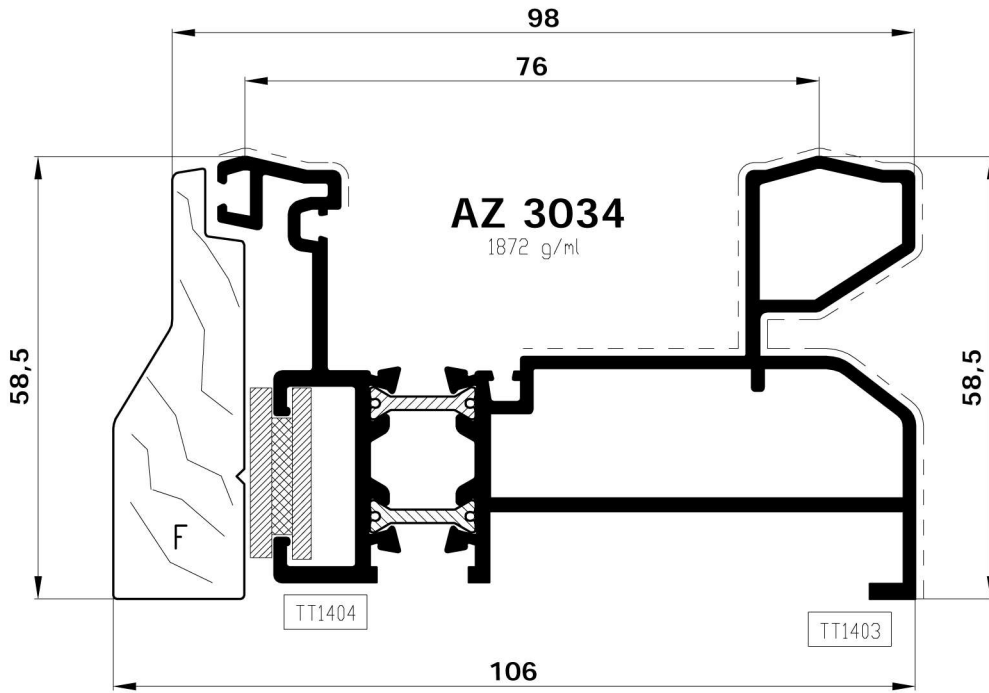

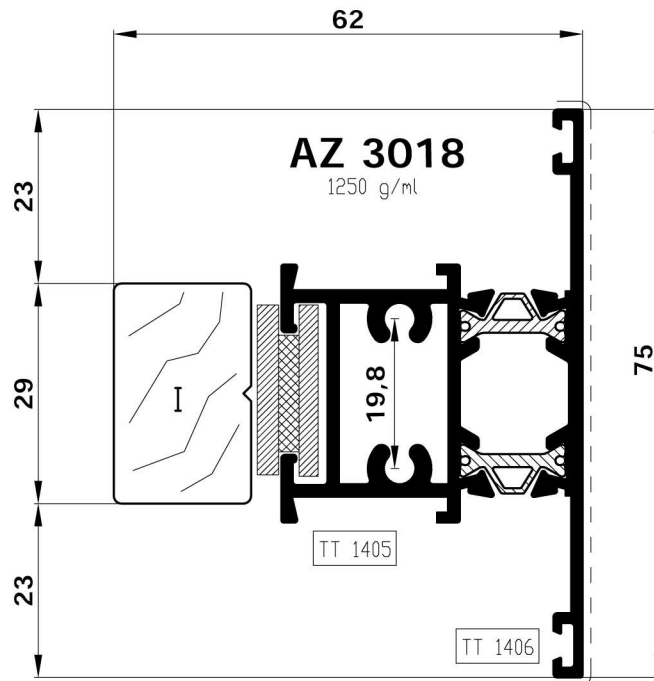
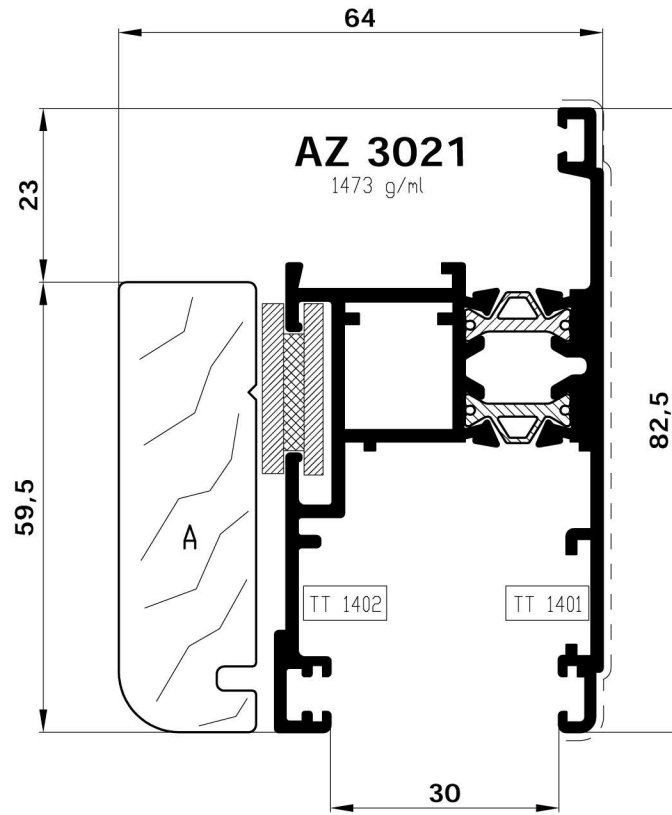

AGGIORNAMENTI ATLANTIS WOOD SLIDE

Anta bombata

scala 1:1

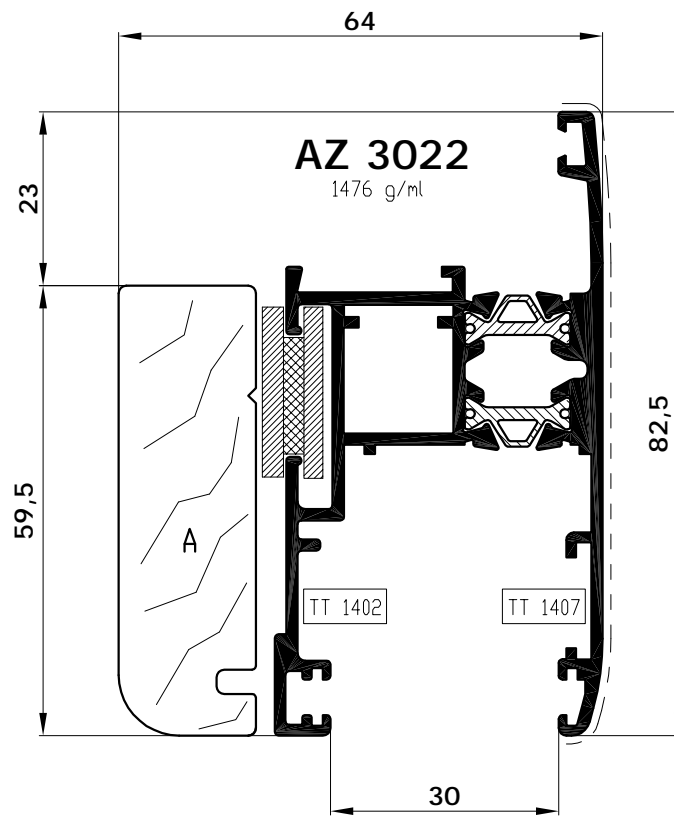

CODICE MATRICE

scala 1:1

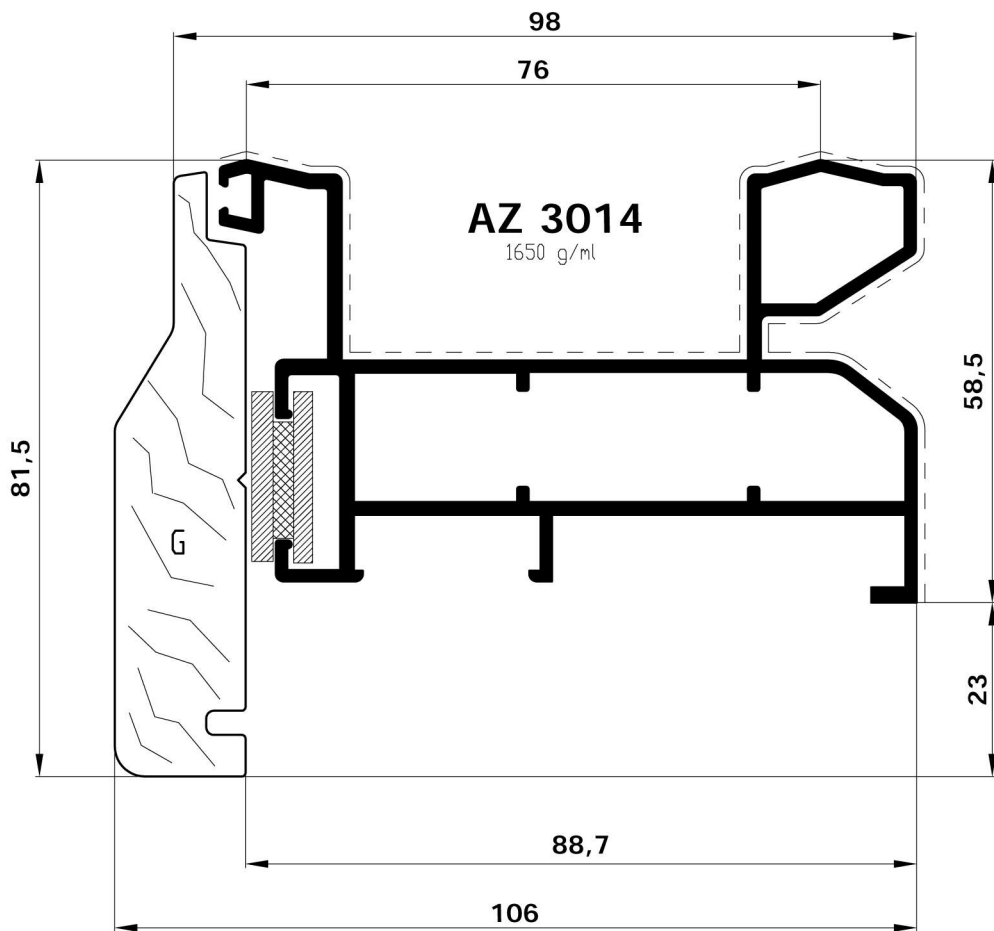
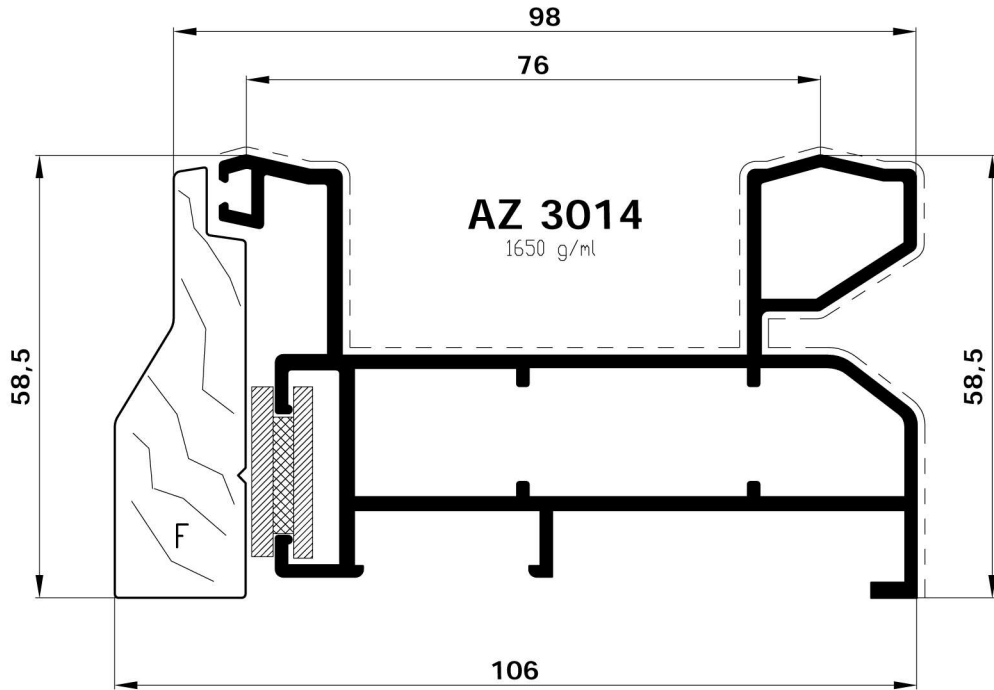

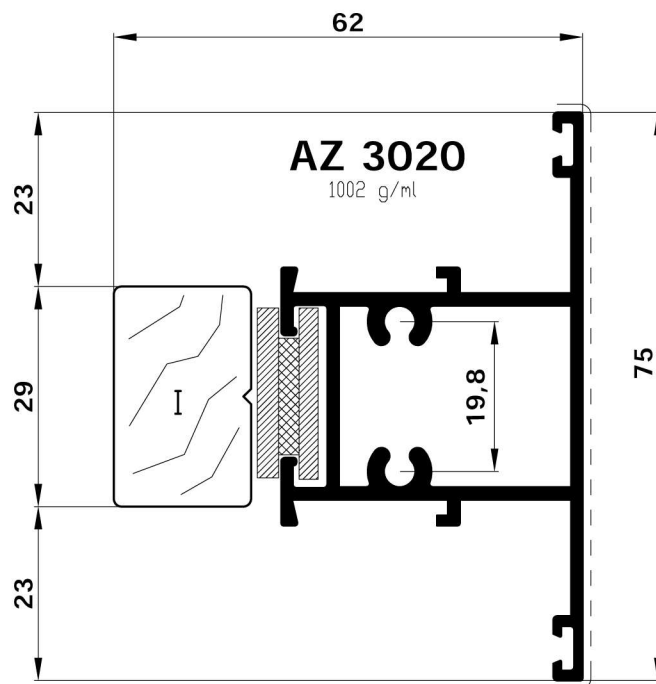
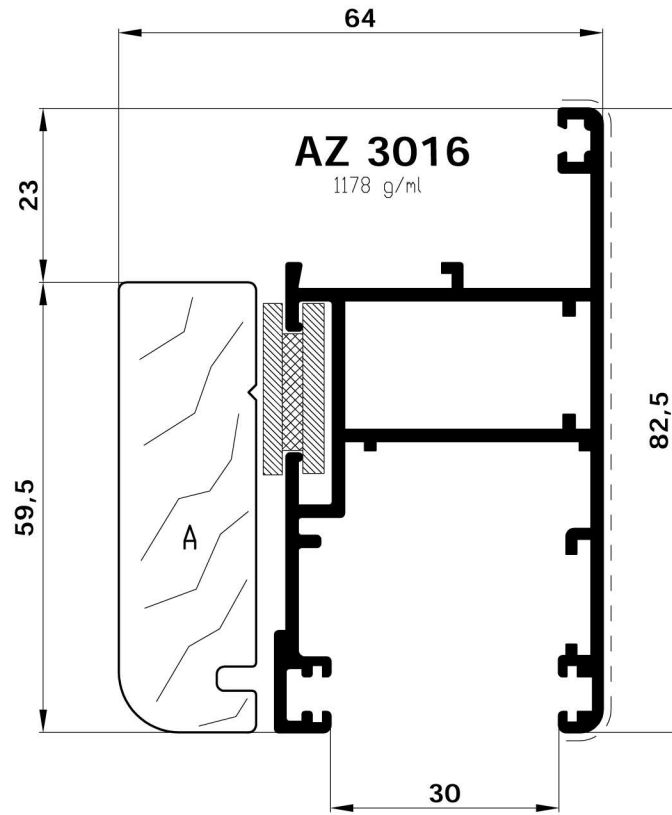

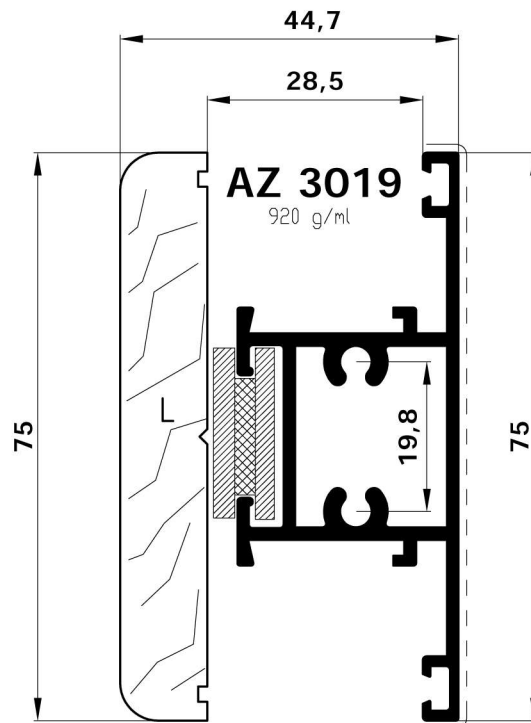
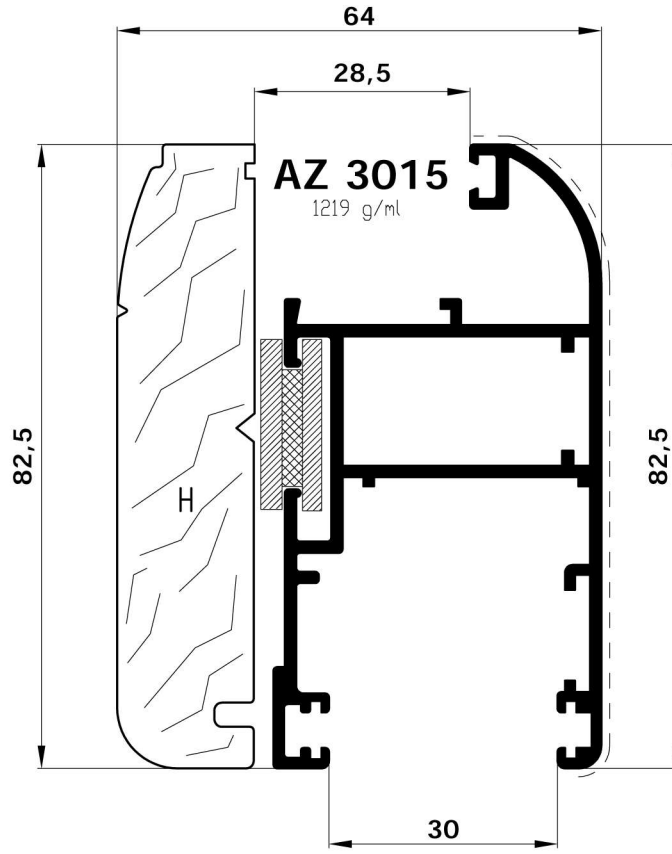

scala 1:1

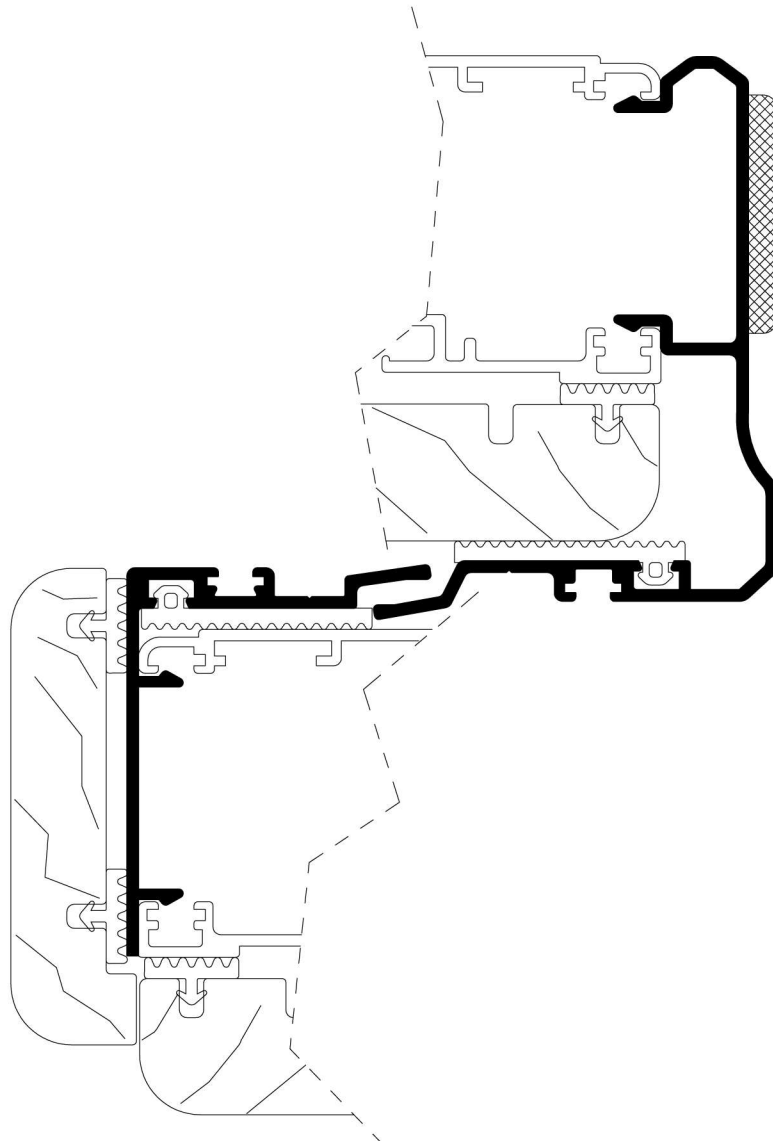
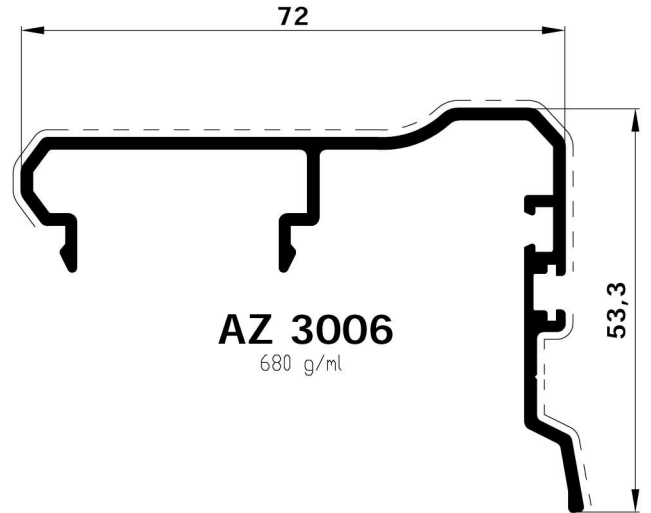
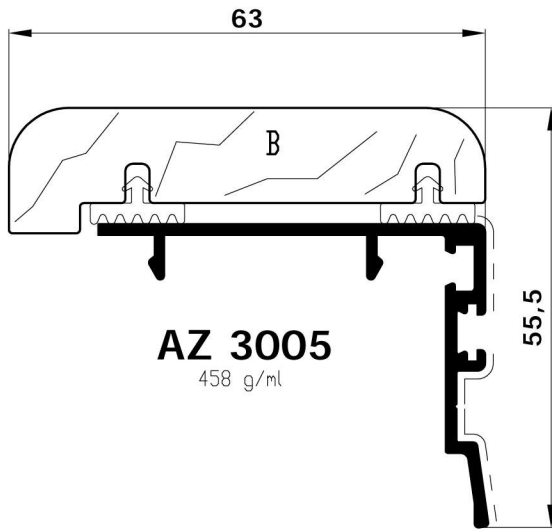

scala 1:1

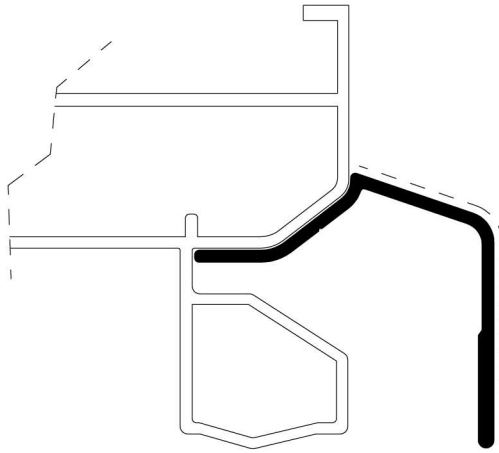

AZ 3010
294 g/ml

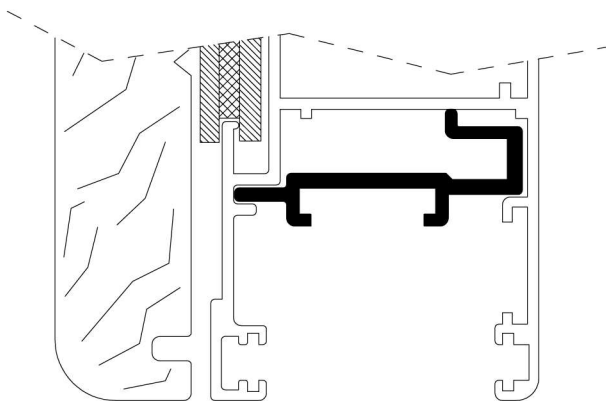
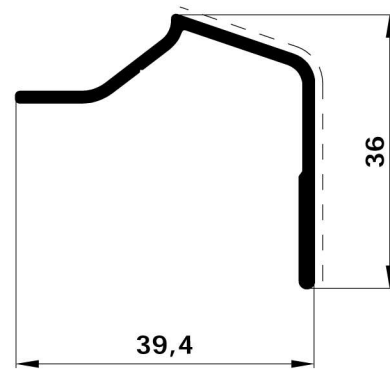

AZ 3011
303 g/ml

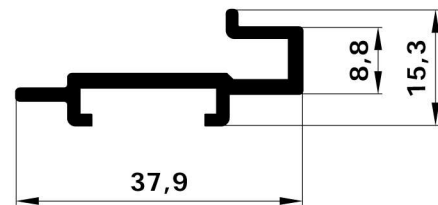

scala 1:1

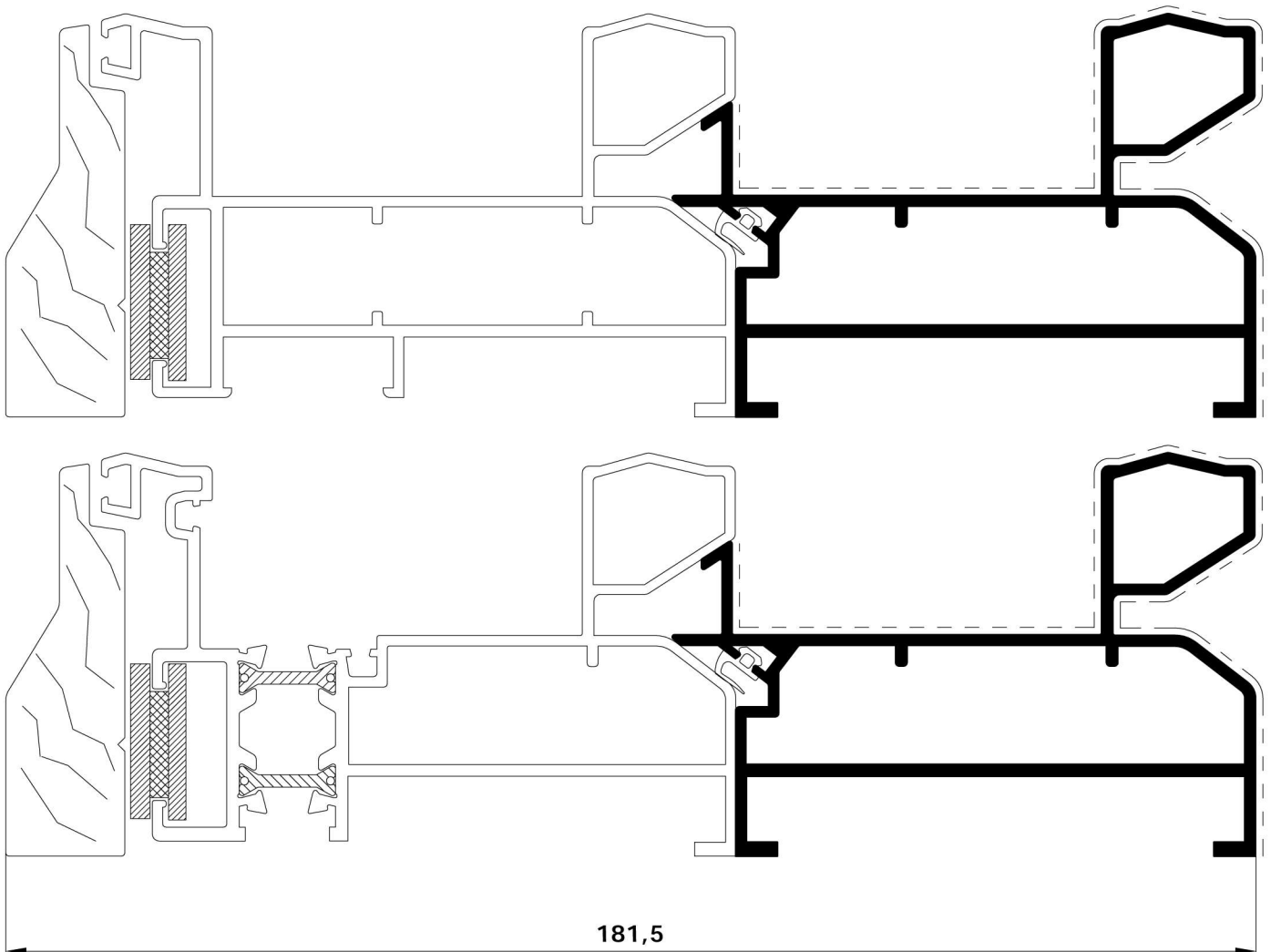
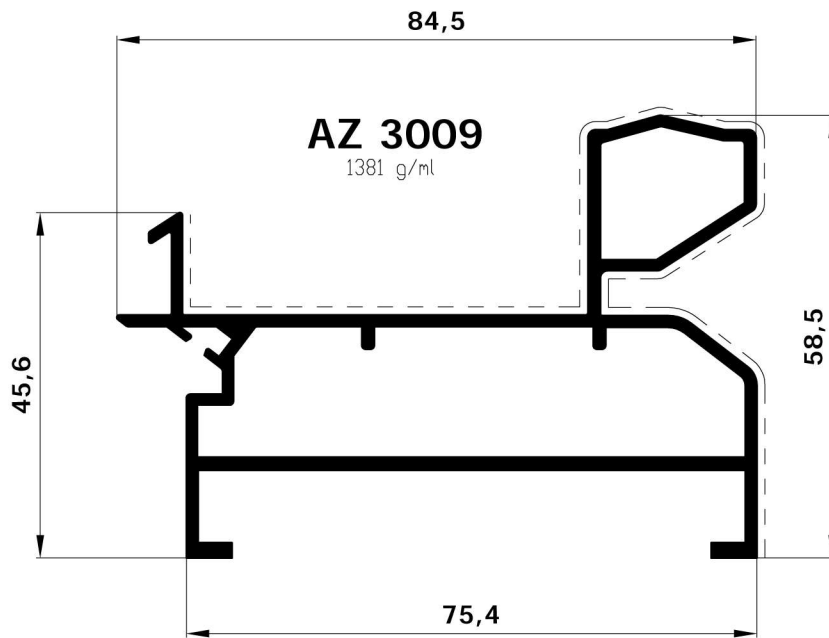

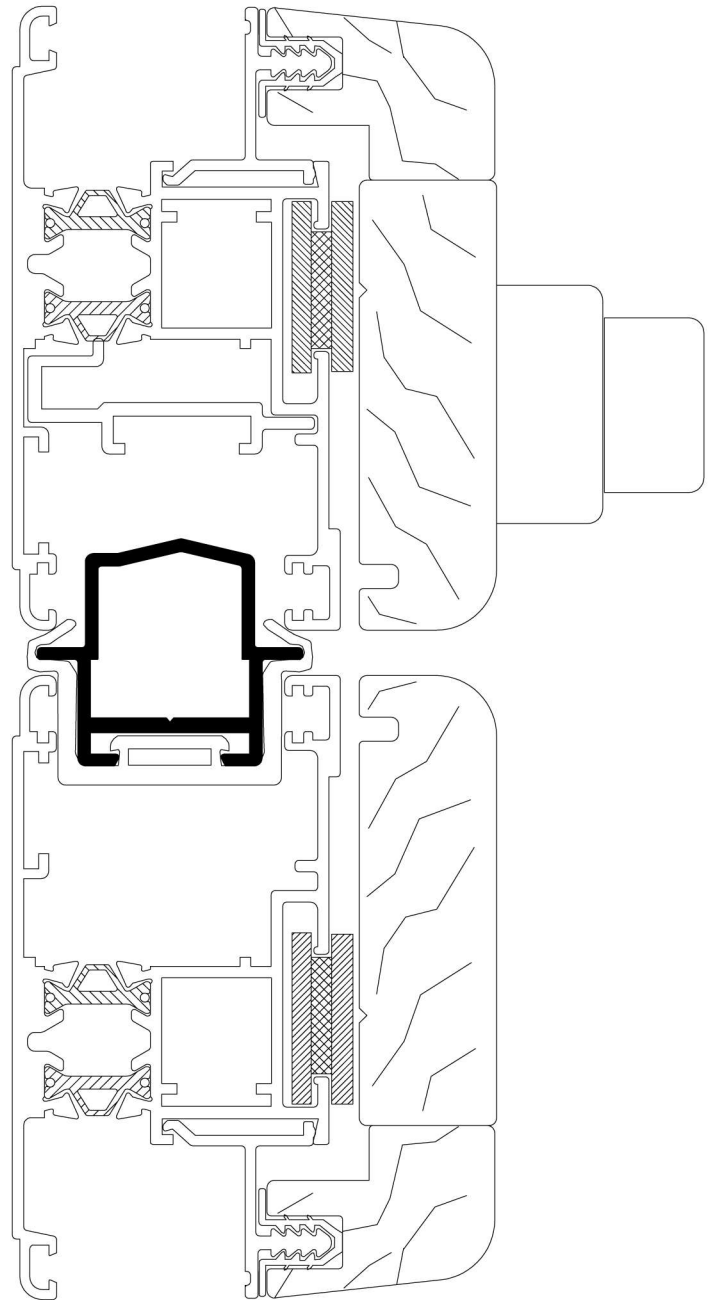
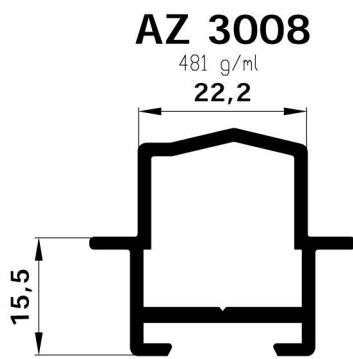

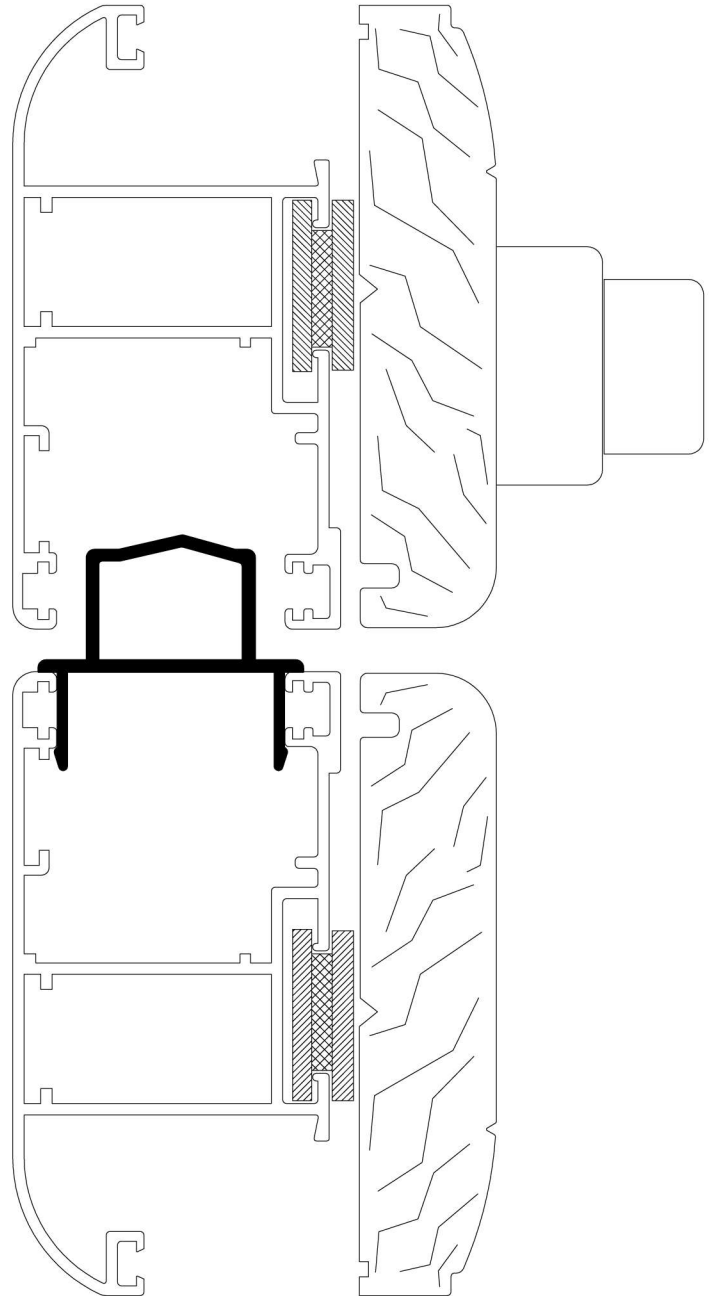
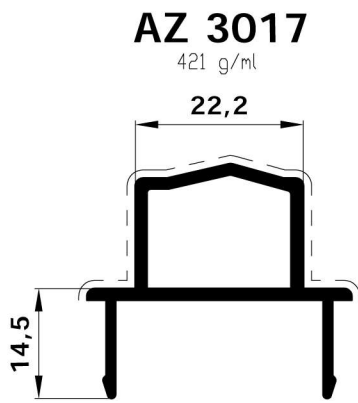

AZ 5018

1536 g/ml

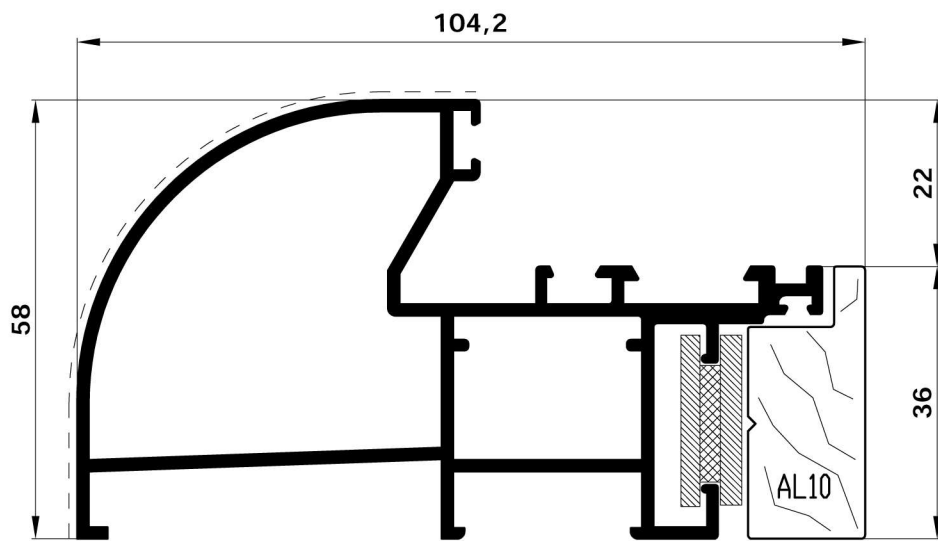

AZ 4909

1520 g/ml

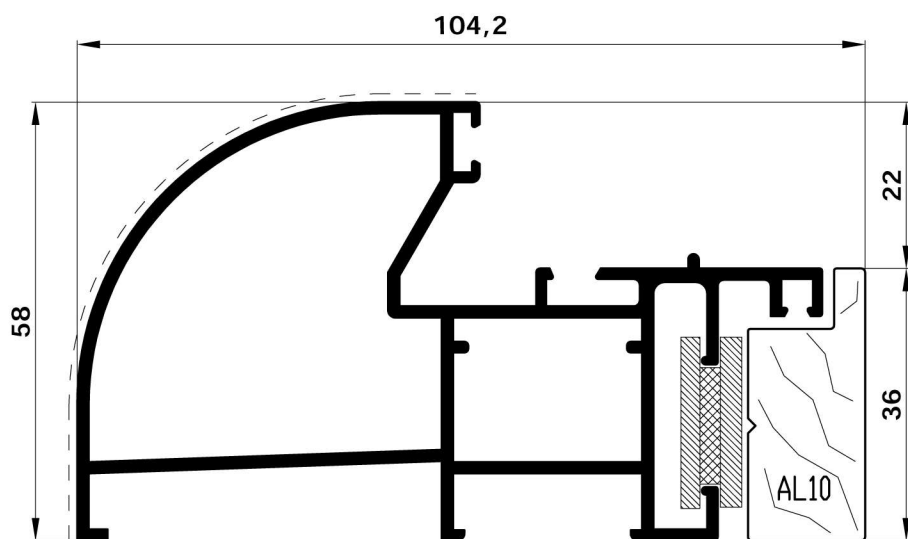

scala 1:1

AZ 3007
230 g/ml

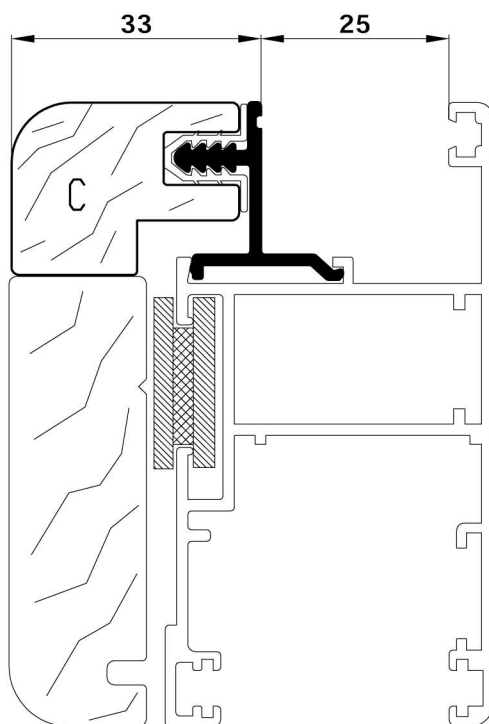

AZ 3012
230 g/ml

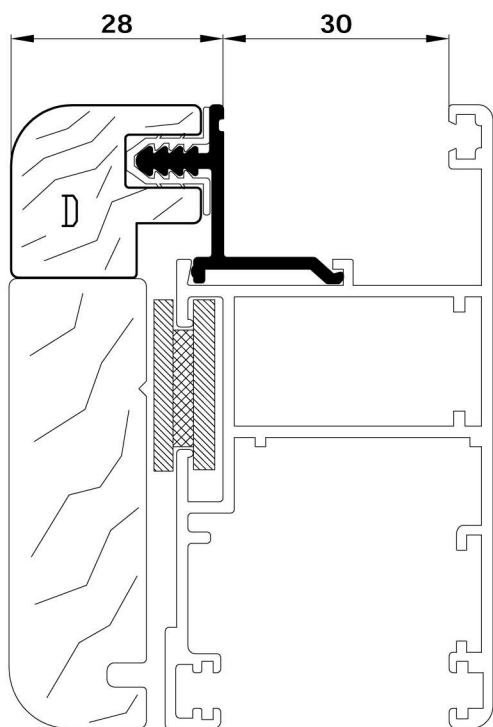

AZ 3013
238 g/ml

